

(Not to scale)

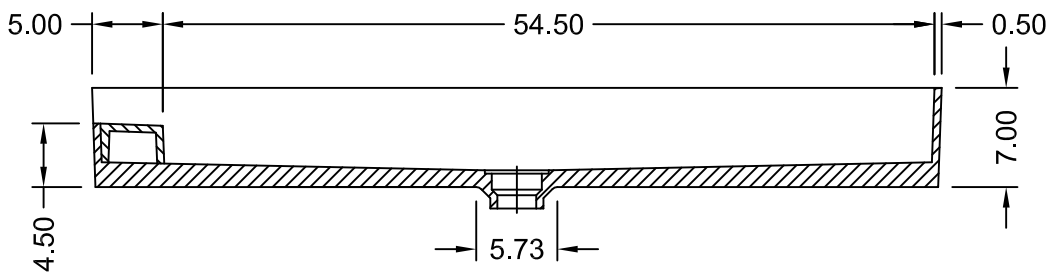

SECTION A-A

SECTION B-B

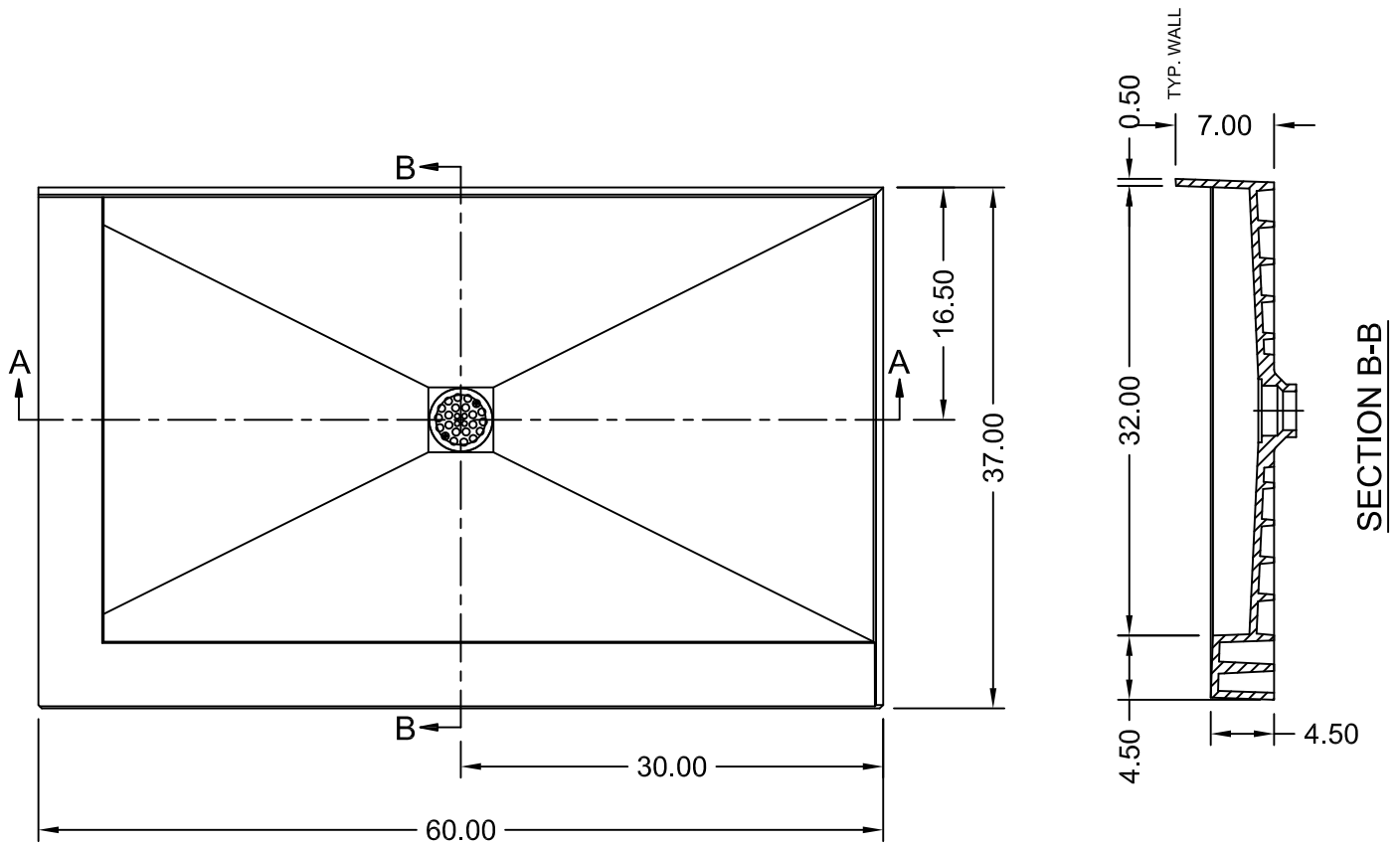

ANSI Z124.1-95 ASTM F462-79  
ANSI Z124.2-95 B45.0-02  
ICC/ANSI A117.1.98 B45.5-02

Toll Free 800.232.6156 techsupport@tileredi.com  
Tel: 954.323.0125  
Fax: 954.344.8064 www.tileredi.com



2015.05.08